

Clout Archery

Archery GB Judge Committee

Clout Archery Training Presentation

By

Neil S E Foden

(AGB National Judge, WAE Continental Judge, WA International Judge Candidate)
(Retired)



Acknowledgements

This presentation was initially inspired by Peter Gregory, who is a dedicated Clout archer

Peter is constantly striving to raise the profile and improve the standard of Clout archery, and to this end he asked if I would produce a document that could be used as a training aid for judges to improve their knowledge of specific clout rules.

Peter's knowledge, experience and input in the production of this presentation can not be understated and is greatly appreciated.

Aims of Presentation

- To present the rules of Clout Archery, both Archery GB and World Archery, in a format that explains and educates
- To provide judges with the knowledge required to give the Archer's confidence that the judges are aware of the specific rules of Clout Archery

Bow Styles & Divisions

Archery GB

Recognise Gentlemen, Ladies and Juniors in the following bow styles

- Recurve (Freestyle) – Equipment as defined in Rule 202
- Recurve Barebow – Equipment as defined in Rule 204
- Longbow – Equipment as defined in Rule 206
- Compound Unlimited – Equipment as defined Rule 207
- Crossbow – Equipment as defined in Rule 210

Bow Styles & Divisions

World Archery

Only recognise Ladies and Gentlemen for Clout Archery and the bow styles are limited to the following

Recurve

Compound

In practice when shooting a World Archery Clout in this country all divisions and bow styles as recognised by Archery GB are included and eligible for both National and Regional records.

The Clout Round

A single Clout Round consists of 36 arrows

A double Clout round consists of 72 arrows

Shooting

Archery GB

Shooting may be either 'two way' or 'one way'.

Six sighter arrows shall be shot in each direction when shooting two ways.

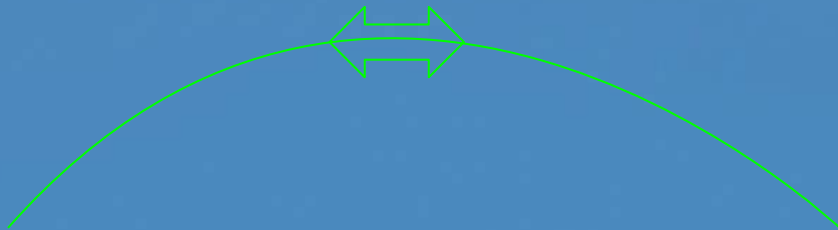

World Archery

Shooting shall be in one direction only.

Six sighter arrows (two ends of three arrows) are permitted preceding the commencement of shooting.

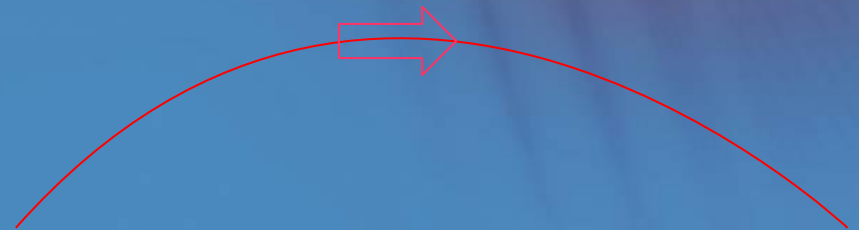

Timing of ends

Archery GB

Archers will shoot ends of three or six arrow details depending on the timing method used

Method 1

2x3 Arrow ends per Archer per detail (2½ minutes)

Method 2

2x3 Arrow ends per Archer per detail (2 minutes)

or

1x6 Arrow ends per Archer per detail (4 minutes)

World Archery

Each athlete shall shoot his arrows in ends consisting of details of three or six arrows.

The maximum time permitted for an athlete to shoot an end of three arrows shall be two (2) minutes. The maximum time permitted for an athlete to shoot an end of six arrows shall be four (4) minutes.

Unshot Arrows

An arrow is deemed to be unshot

Archery GB

An arrow shall be deemed not to have been shot if part of the arrow shaft lies within 3 metres of the shooting line.

World Archery

The athlete can touch it with their bow without moving their feet from their position in relation to the shooting line.

Resolution of Ties

Archery GB

First by the number of Hits

Second by the number of Clouts

If all elements are the same, the archers shall be declared equal

World Archery

First by the least number of misses

If the tie is still undecided, then the least number of ones, and so on

Should all arrows be the same, the athletes so tying shall be declared equal

Over Shoot

The Organisers shall take all reasonable steps to ensure that there is no risk to people, animals or property from arrows that miss the target area. An overshoot past the flag and to either side is required.

*The overshoot distance is **50 yards***

- Side safety distances should be
 - 20 yards at 100 yards
 - 25 yards at 150 yards
 - 30 yards at 180 yards and remain at 30 yards thereafter

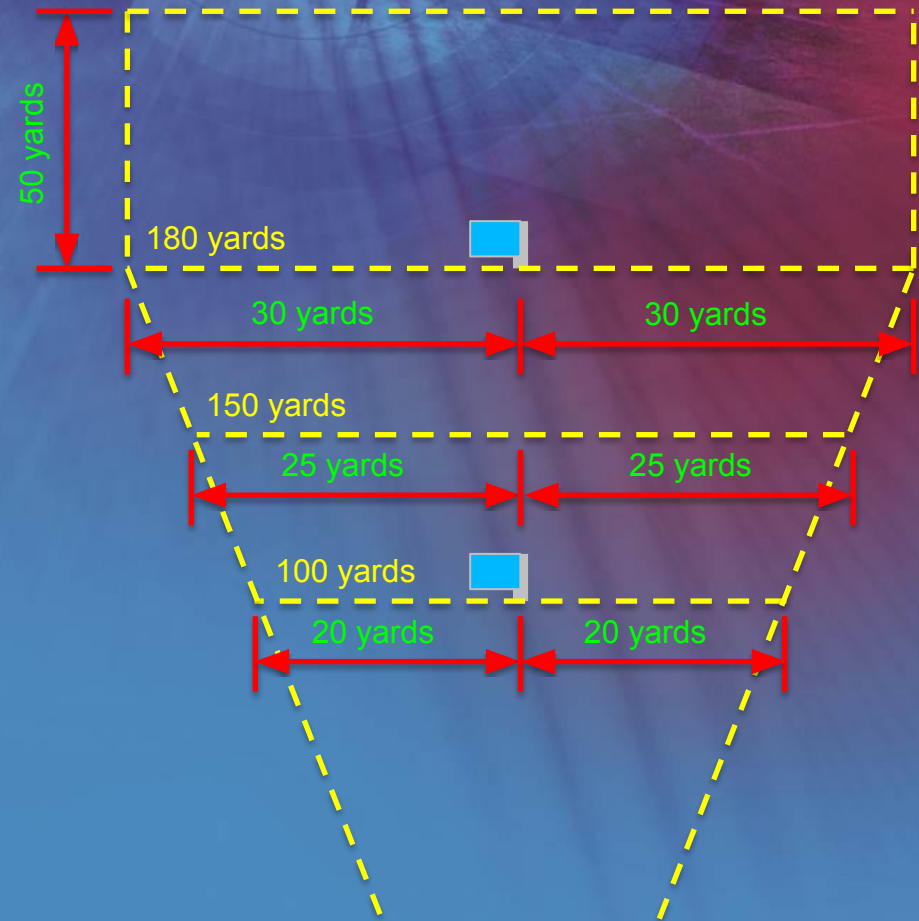

Instruction

All archers must have received instruction in Clout shooting prior to competitions. To confirm this, each entry form must contain a certificate to be signed by each archer before shooting commences:

Example

*I have received instruction in Clout shooting prior to this tournament.
Archer's signature.*

Trajectory

The bow must be drawn in such a way that the angle the arrow makes with the horizontal must never be greater than that which it makes at the point of release/loose

High Trajectory Clout shooting is BANNED except for Longbows



Clout Flags

Archery GB

The centre of the target shall be marked by a brightly coloured distinctive flag

The flag should be **12 inches square**

The flag should be *set as close to the ground as possible*

Note:

The stick should not project above the flag

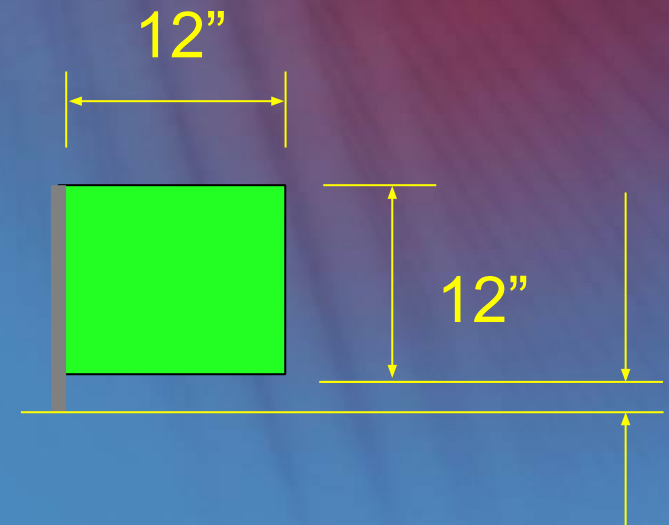

Clout Flags

World Archery

The centre of the target shall be marked by a brightly coloured distinctive flag.

The Shape of the flag should be

Triangular

and measure *80x30 cm Maximum*

The distance above ground to the underside of the flag should be

50cm Maximum

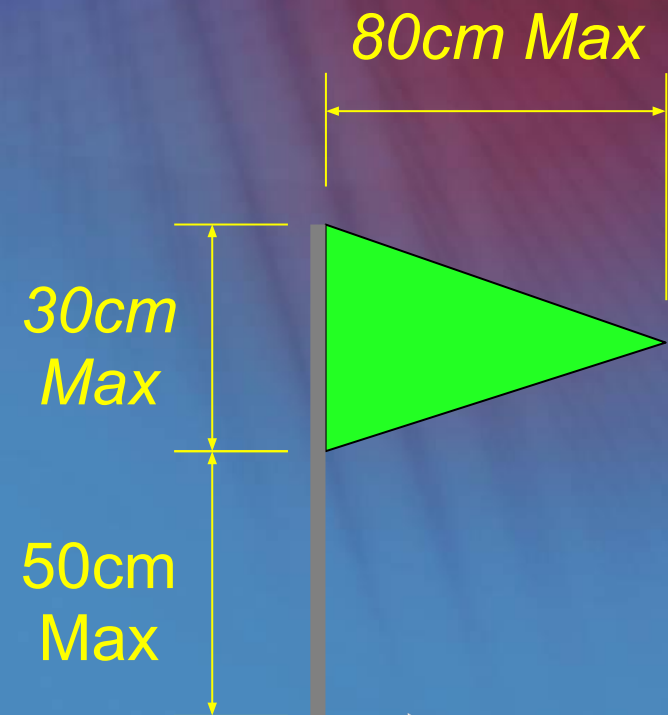

Clout Flags

The Clout should be constructed with a timber pole, preferably a broom stale cut to the required length. It is advisable not to use anything of a smaller diameter as these could bend when the cord is being pulled round the circle.

The Flag should be fabricated from a light flexible material, which can be blown about by the wind and which will not damage the arrows. Various bright colours should be used, and no two adjacent Clouts should have the same colour flag.

Scoring Zones

Archery GB

There are five scoring zones, which can be marked either on the ground or a non-stretch cord or tape can be used which is looped round the centre stick.

The zone values and radii are:

Gold = *5 Points*

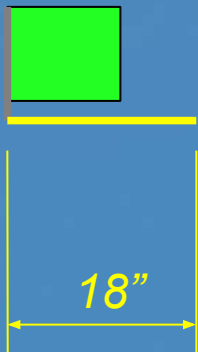

Scoring Zones

Archery GB

There are five scoring zones, which can be marked either on the ground or a non-stretch cord or tape can be used which is looped round the centre stick.

The zone values and radii are:

Red = *4 Points*

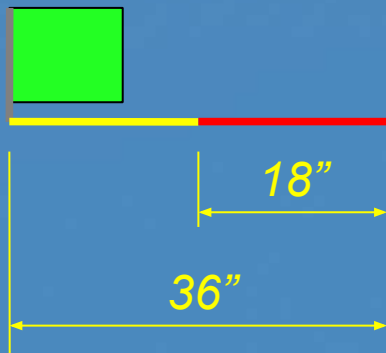

Scoring Zones

Archery GB

There are five scoring zones, which can be marked either on the ground or a non-stretch cord or tape can be used which is looped round the centre stick.

The zone values and radii are:

Blue = *3 Points*

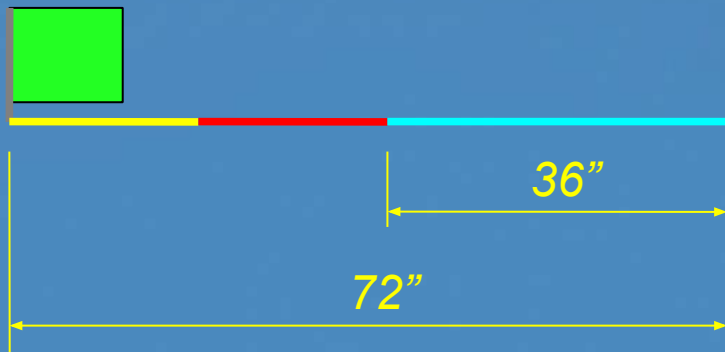

Scoring Zones

Archery GB

There are five scoring zones, which can be marked either on the ground or a non-stretch cord or tape can be used which is looped round the centre stick.

The zone values and radii are:

Black = *2 Points*

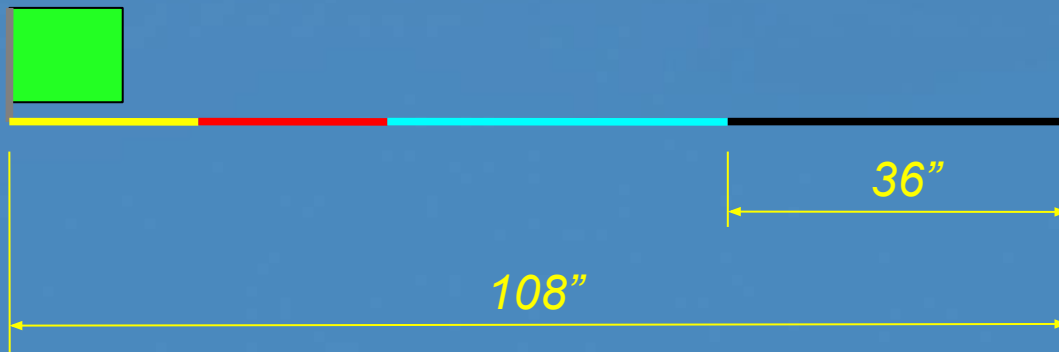

Scoring Zones

Archery GB

There are five scoring zones, which can be marked either on the ground or a non-stretch cord or tape can be used which is looped round the centre stick.

The zone values and radii are:

White = *1 Point*

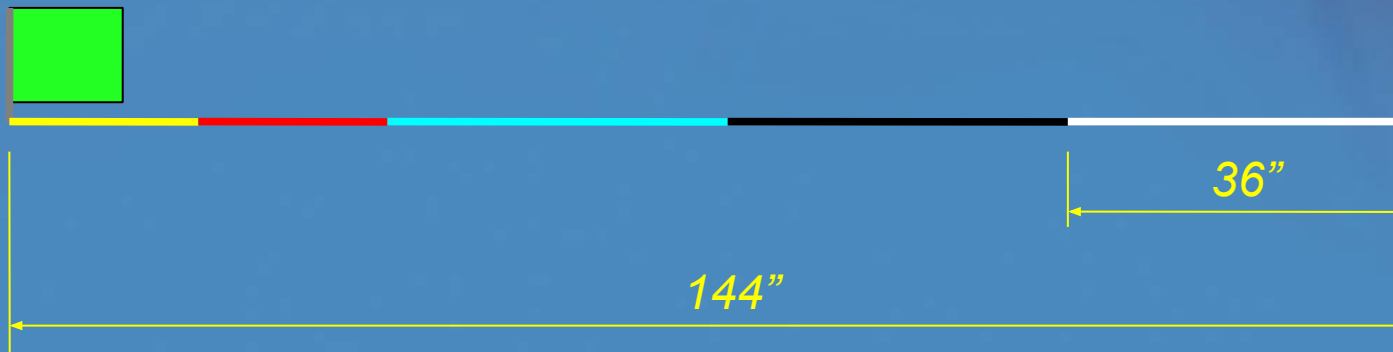

Scoring Zones

World Archery

There are five scoring zones, which can be marked either on the ground or a non-stretch cord or tape can be used which is looped round the centre stick.

The zone values and radii are:

Gold = *5 Points*

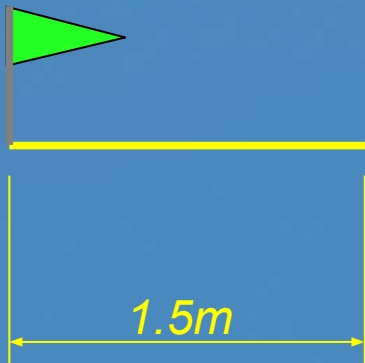

Scoring Zones

World Archery

There are five scoring zones, which can be marked either on the ground or a non-stretch cord or tape can be used which is looped round the centre stick.

The zone values and radii are:

Red = *4 Points*

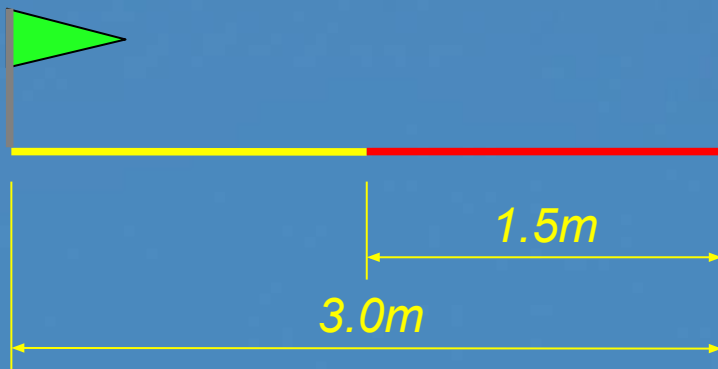

Scoring Zones

World Archery

There are five scoring zones, which can be marked either on the ground or a non-stretch cord or tape can be used which is looped round the centre stick.

The zone values and radii are:

Blue = *3 Points*

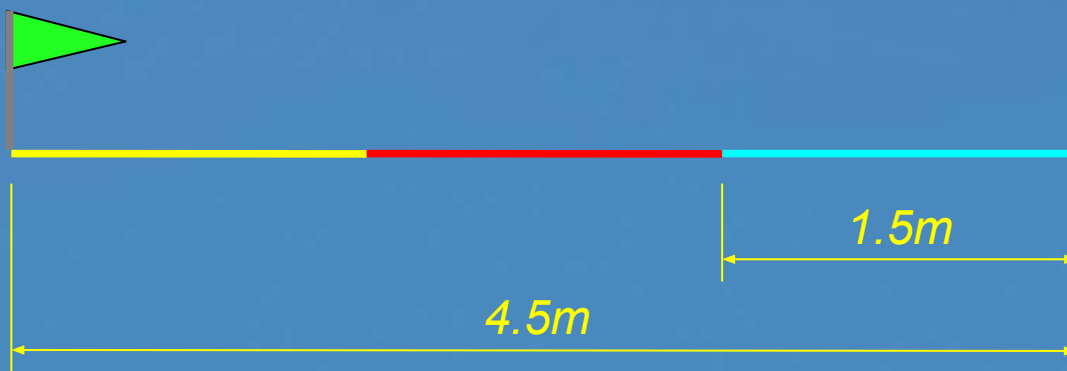

Scoring Zones

World Archery

There are five scoring zones, which can be marked either on the ground or a non-stretch cord or tape can be used which is looped round the centre stick.

The zone values and radii are:

Black = *2 Points*

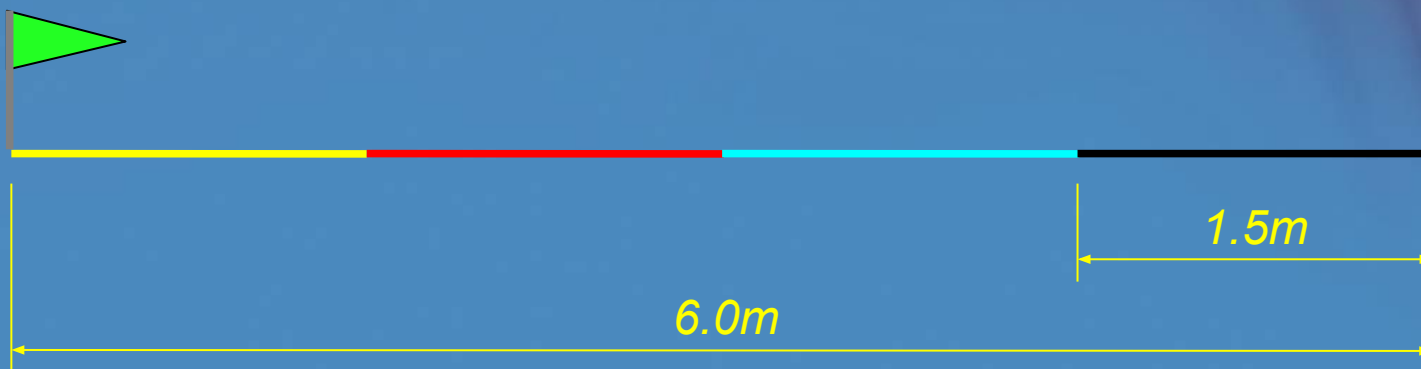

Scoring Zones

World Archery

There are five scoring zones, which can be marked either on the ground or a non-stretch cord or tape can be used which is looped round the centre stick.

The zone values and radii are:

White = *1 Point*

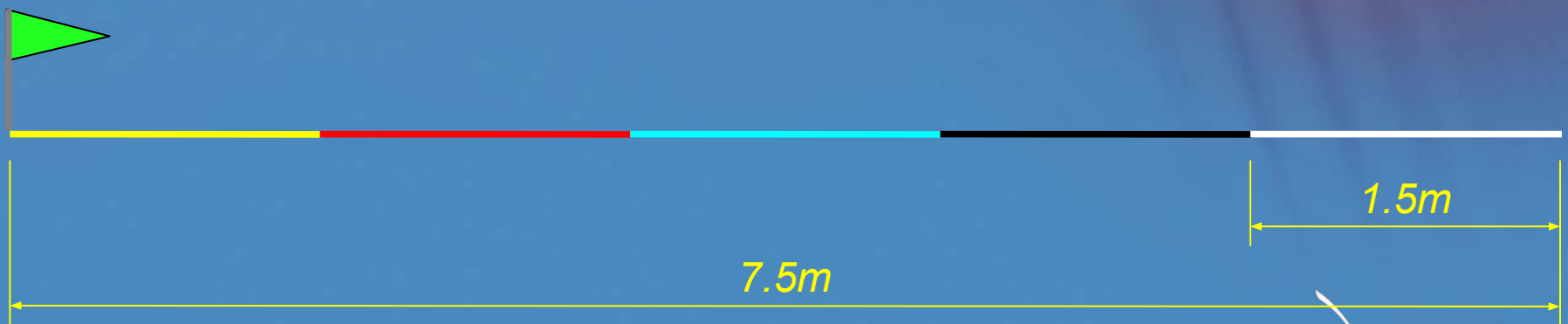

Scoring Ropes

All ropes used for scoring purposes should be made from a non-stretch material.

The scoring zones should be clearly defined along the length of the rope, this is usually done by applying coloured tape to each scoring zone on the rope.

A loop should be incorporated into each end of the rope. One end will go around the clout pole, while a broom stake equipped with a hook can be attached to the other loop to aid drawing the rope round the clout circle when scoring arrows.

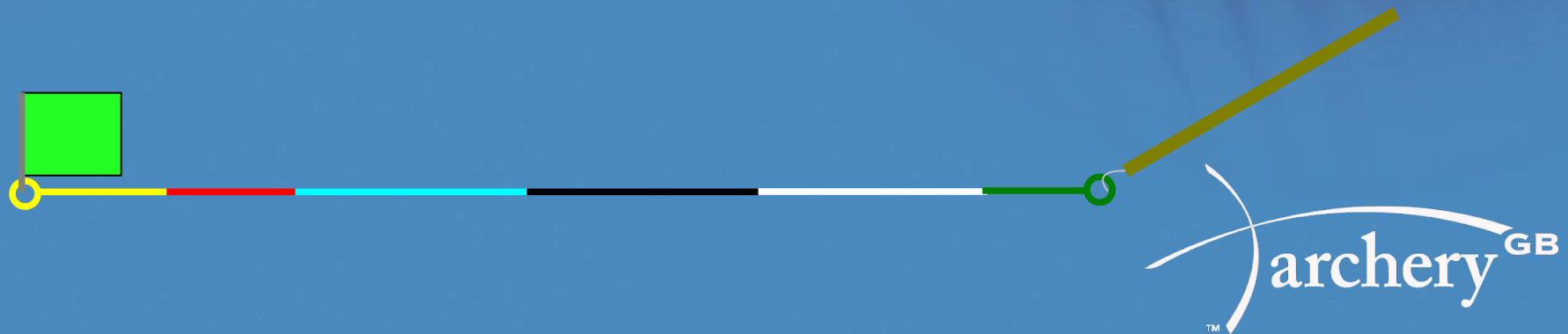

Distances

Archery GB

The distances for the Clout is:

Gentlemen

Ladies

Juniors u21

Juniors u18

Juniors u16

Juniors u14

Juniors u12



Distances

World Archery

The distances for the Clout is:

Gentlemen
(Compound)

185 Meters

Gentlemen
(Recurve)

165 Meters

Ladies
(Compound)

165 Meters

Ladies
(Recurve)

125 Meters

Shooting Line

Distances

World Archery

World Archery do not recognise Juniors or Longbows in the Clout discipline and therefore there are no set distances

Distances

Archery GB

Archery GB recognise the following distances for National record claims, for both the single & double World Archery and the Archery GB Metric Clouts.

Gender Age Group	Compound Bows	Non Compound Bows
Gentlemen	185m	165m
Ladies	165m	125m
Juniors under 21	165m	125m
Juniors under 18	125m	110m
Juniors under 16	110m	90m
Juniors under 14	90m	75m
Juniors under 12	90m	75m

Tolerances

There are no tolerances listed in either the Archery GB or World Archery rule books for scoring zone dimensions for Clout Archery

There are also no tolerances listed in either the Archery GB or World Archery rule books for Clout distances

In both cases it is necessary to use a bit of common sense when checking these dimensions and allow a sensible tolerance

General Guidance

Although the following items are not rules and do not strictly fall under the province of the judges, you should nonetheless be aware of them.

The maximum number of Archers shooting at any single clout should be about 20.

The shooting line should be divided into zones which will comfortably accommodate the number of archers shooting at the individual clout. It is a good idea to have a coloured peg at the start and end of each zone, and that the colour of the pegs matches the colour of the Clout flag.

The centre of the zone should be also marked with a vertical line to indicate the centre of the target.

The Clout scoring area's should be located so that they do not overlap each other. In fact as wide a gap as possible, given the confines of the ground, between area's should be aimed for by the tournament organiser when setting out the field.

Scoring

No person other than the appointed scorers shall enter the target area until all arrows have been withdrawn and placed in their respective scoring groups.

An arrow withdrawn by anyone other than an appointed scorer shall not be scored.

The appointed scorers shall not take any arrows into the target area.

Scoring

Colour Sergeants

The duties of the colour Sergeant is to collect the arrows from within the scoring zone they have been allocated.

Once all the arrows have been collected they should be laid out in groups, on top of the cord, within the coloured area for the zone they relate too.

A good procedure to adopt, is to encourage Colour Sergeants to rotate along the colour zones at each preceding end.

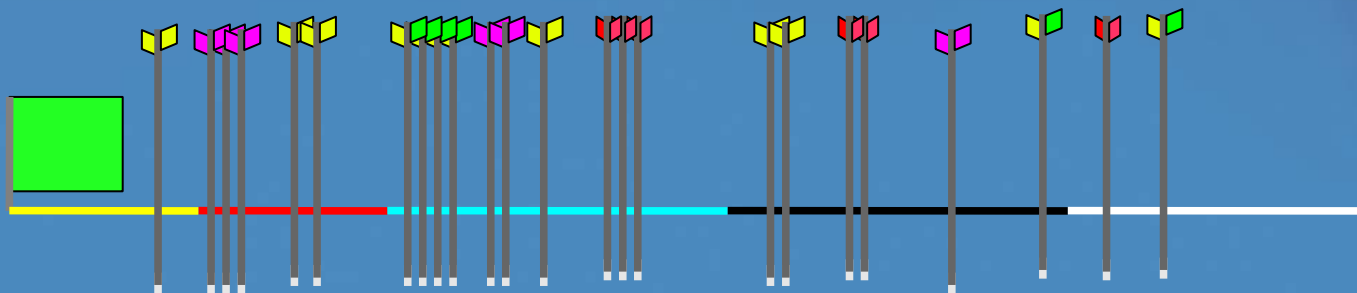

Scoring of Arrows

What value would you award to the arrow in the following situation

Value ? *5 Points*

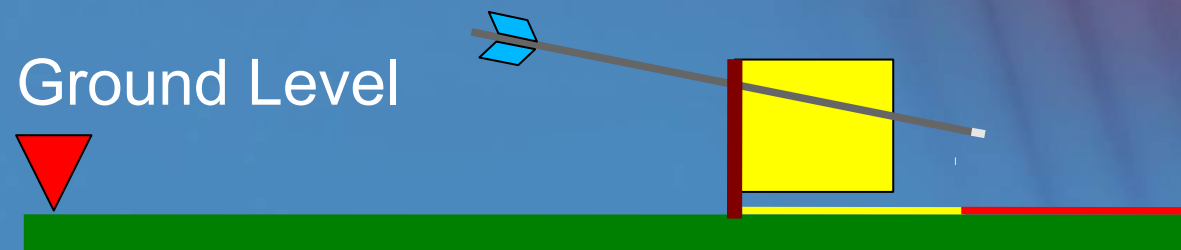

Scoring of Arrows

What value would you award to the arrow in the following situation

Value ? *4 Points*

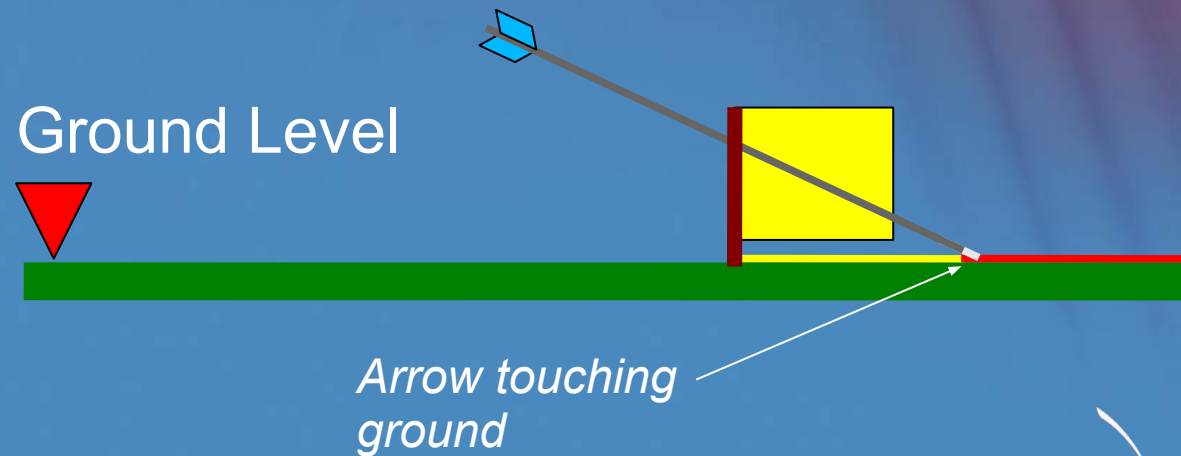

Scoring of Arrows

What value you would award to the arrow in the following situation

Value ? *4 Points*

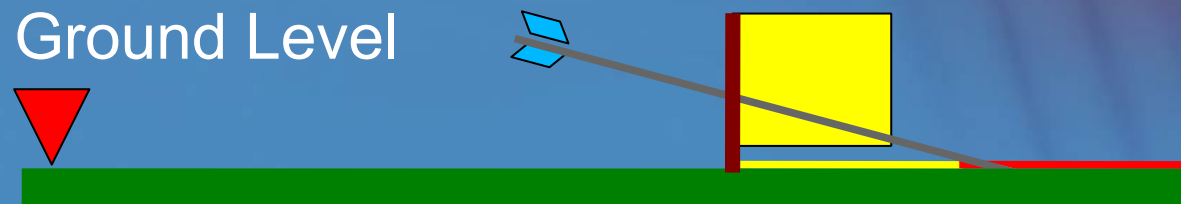

Scoring of Arrows

What value would you award to the arrow in the following situation

Value ? *5 Points*

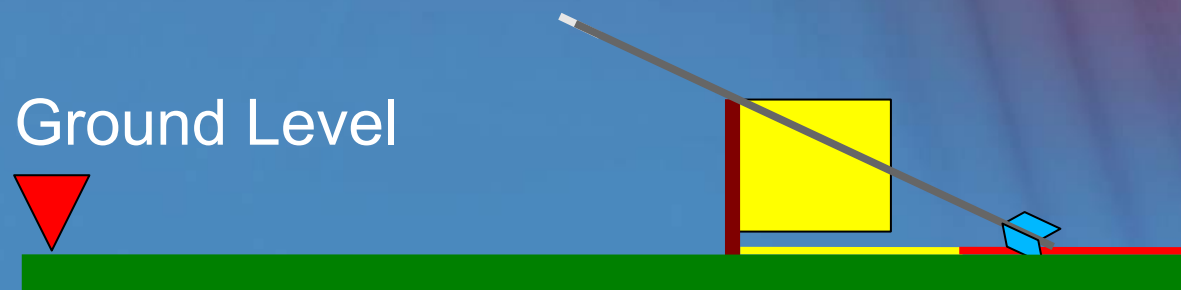

Scoring of Arrows

What value would you award to the arrow in the following situation

Value ? *4 Points*

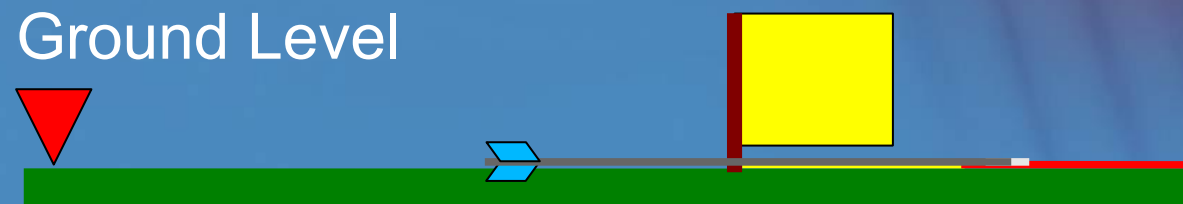

Scoring of Arrows

What value would you award to the arrow in the following situation

Value ? *5 Points*

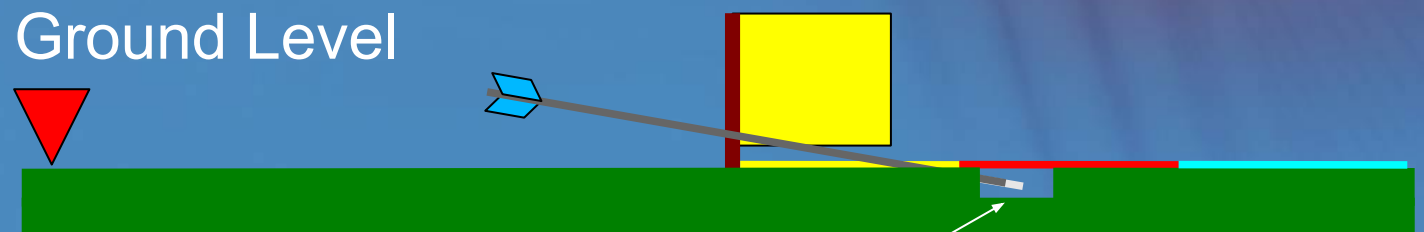

Rut in ground

Scoring of Arrows

What value would you award to the arrow in the following situation

Value ? *4 Points*

Push grass down to find where arrow enters the ground

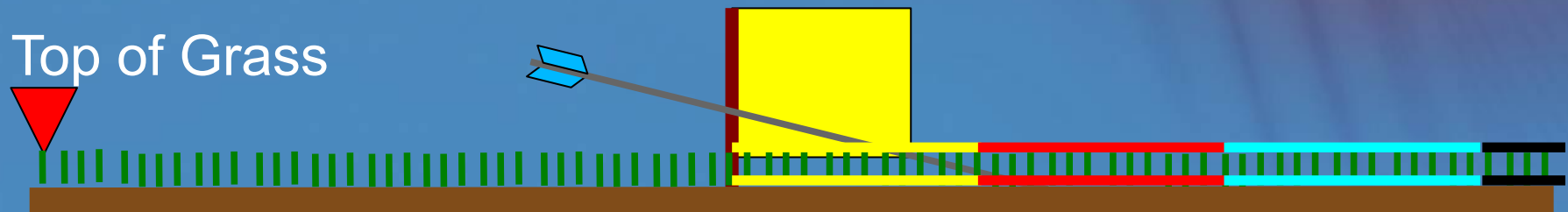

Scoring of Arrows

Which arrow would win the best Clout

Arrow ? **a**

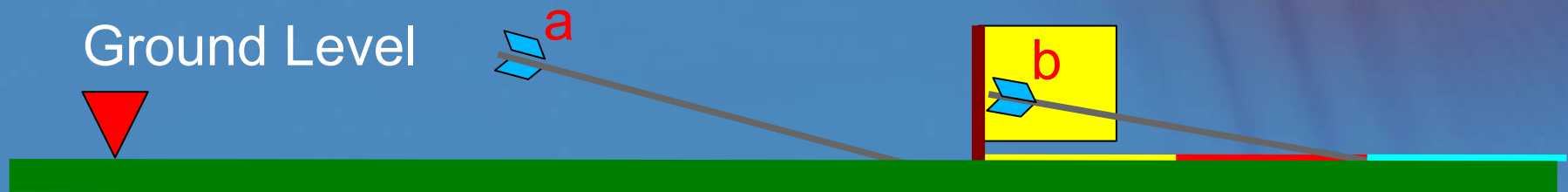

Scoring of Arrows

Which arrow would win the best Clout

Arrow ? **a**



Possible problems

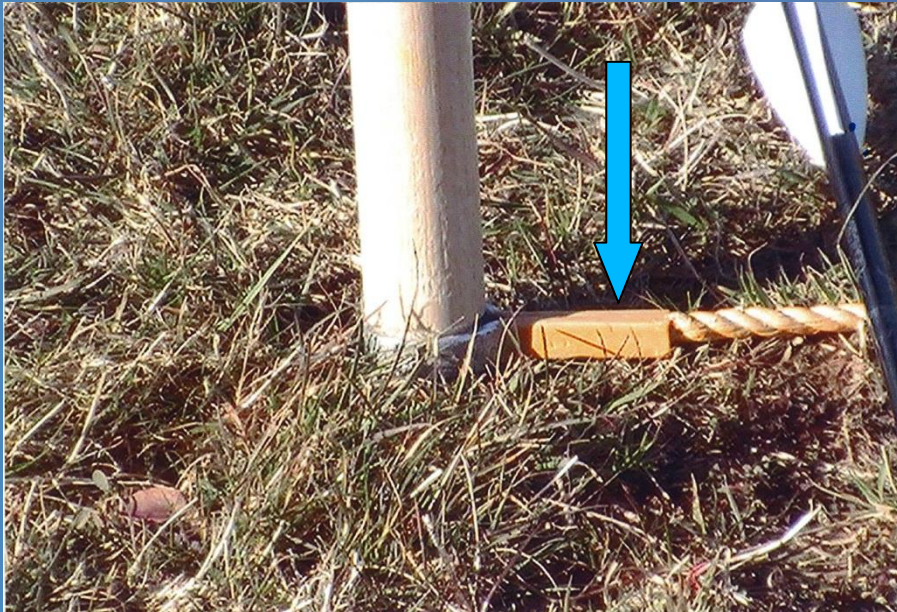

Problem

Rope attachment to clout pole is a metal fixing which could damage arrows or deflect them out of the scoring zone(s).

Remedy

This rope should be replaced if possible, or remove it from the post between scoring ends.

Possible problems

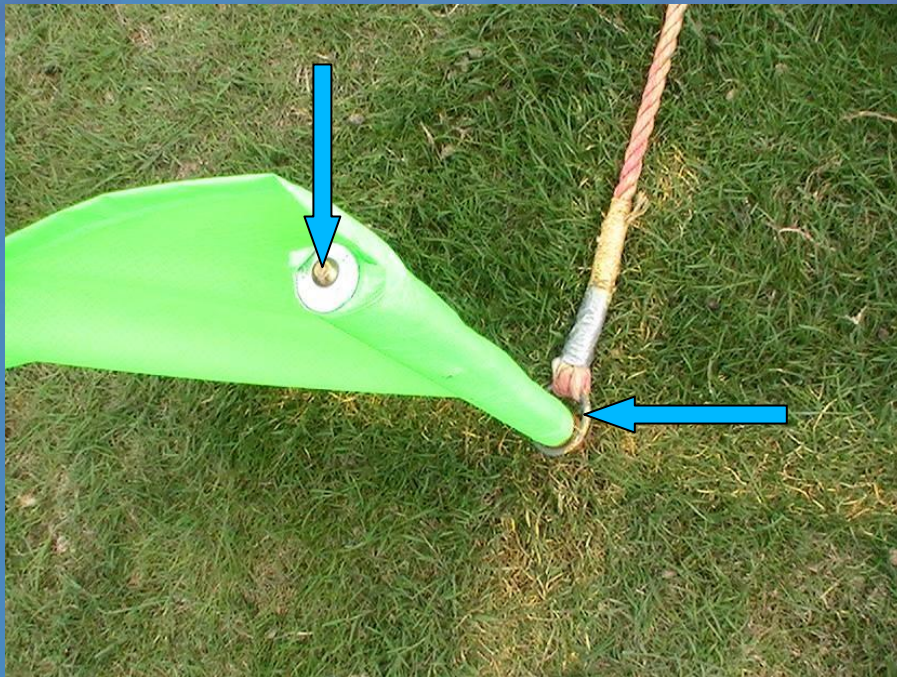

Problem

Rope attachment to clout pole is a metal fixing & the pole looks to contain a metal bar, both of which could damage arrows or deflect them out of the scoring zone(s).

Remedy

Replace the pole & either replace the rope if possible, or remove it from the post between scoring ends.

Possible problems

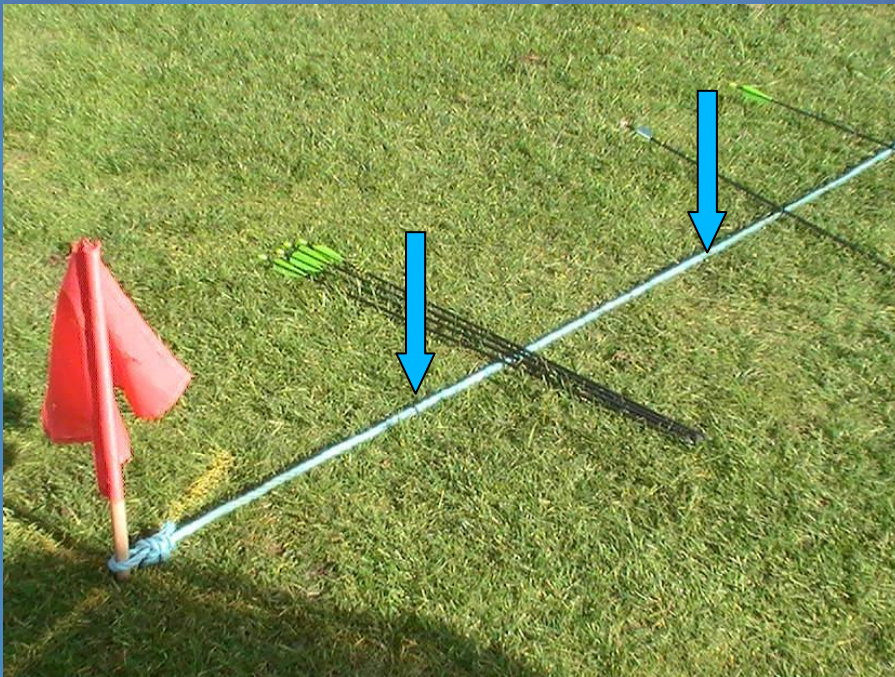

Problem

The rope only has a black mark to indicate the division between scoring zones.

Remedy

Replace the rope if possible, if not, be vigilant during scoring for possible miscalls. Advise organiser of correct procedure for marking rope.

Possible problems



Problem

The archers are within the scoring zone collecting arrows, but still have arrows in their quivers.

Remedy

Tell the archers to come out of the scoring zone and remove the arrows from their quivers. Once this is done they may return and continue scoring.

Possible problems



Problem

The extent of the rope with no pressure on is marked by an arrow. When pressure is applied the rope stretches (about 50mm in this case).

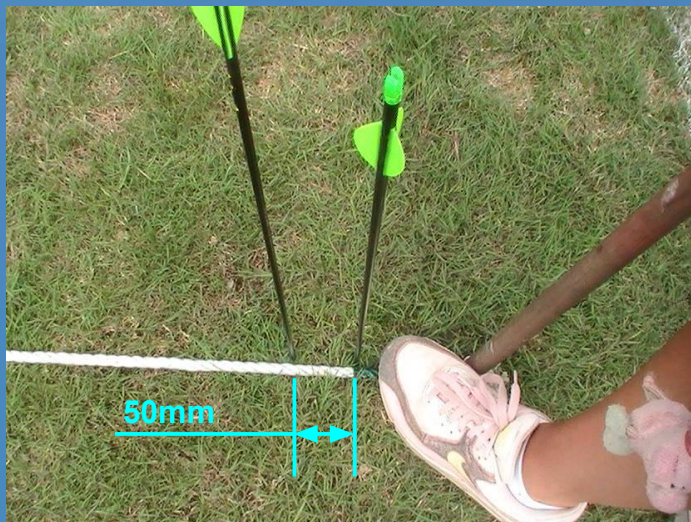

Remedy

Replace the rope. If this is not possible you must determine the best way to check that the rope is not stretched while arrows are being collected.

Clout Sights

Due to the distances shot in clout very few archers can shoot using a conventional sight arrangement, which means most of the sights you will see on a shooting line are custom built to suit the individual archer.

This can mean that some sights push the boundary of what is legal, so you need to check each sight carefully at equipment inspection for any discrepancies.

The following slides show a variety of legal and illegal sights

Clout Sights- Legal Recurve



Clout Sights – Legal Recurve



Clout Sights – Legal Recurve



Clout Sights – Legal Compound

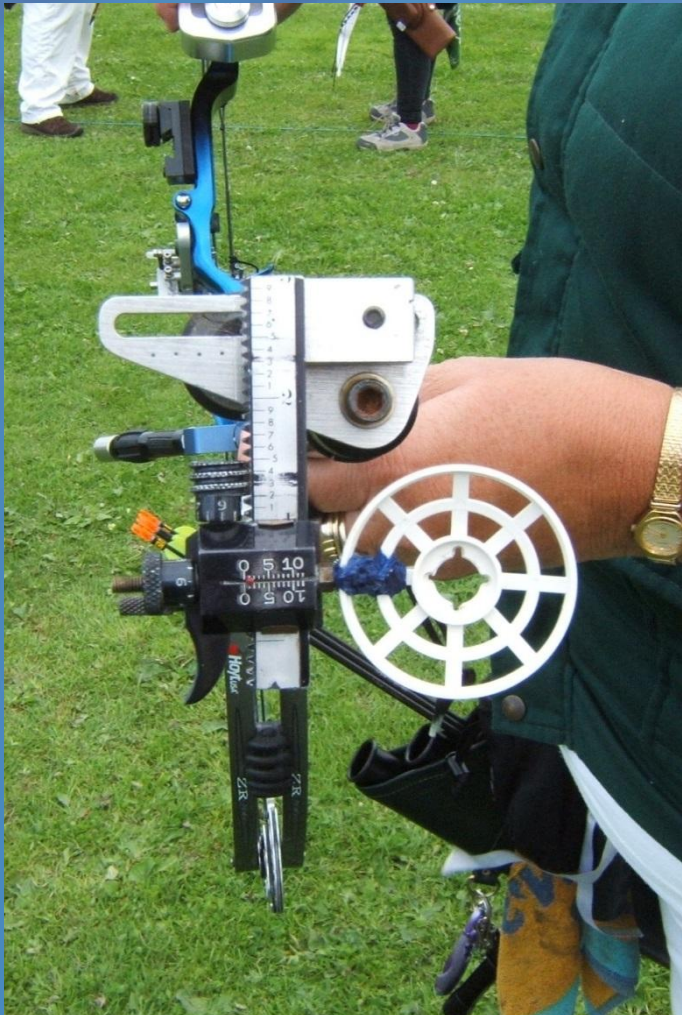

Clout Sights – Illegal Recurve



3 Sighting
Points

Clout Sights – Illegal Recurve



Two sight points

Clout Sights – Illegal Recurve



This sight contains two mirrors which create a prism
This is illegal for use on a Recurve but is legal on a
Compound

Clout Sights – Illegal Recurve



Sight contains full length lines which act as multiple sight marks and can also aid levelling

Barebow Handles

One item of equipment that can tend to be overlooked is the handle of bows in the Barebow class.

It is important to remember that the pattern or design of some handles, while legal for the Recurve class, would be illegal for the Barebow class unless they had tape applied.

The following slides show a variety of handles that would be illegal unless the lower section was covered with tape.

Bow Handles – Illegal Recurve Barebow



The bolts and slots on the back of the handle would give the archer a sighting advantage over other competitors, therefore they would need to be taped over before the bow could be used in the Barebow class.

Bow Handles – Illegal Recurve Barebow



The pattern design on the back of this handle would give the archer a sighting advantage over other competitors, therefore it would need to be taped over before the bow could be used in the Barebow class.

Tassels

The Tassel Award for Clout archers has been in operation for some years now. First introduced in 1996 within the boundaries of Northern Counties and later adopted by Archery GB nationally. Although the scheme is nationally run, Northern Counties Archery Society administers the scheme and issues the awards.



Tassel Award qualifying scores for Archery GB Clout rounds

Badge	Longbow	Barebow	Recurve	Compound
White	25 - 49	50 - 99	75 - 124	75 - 124
Black	50 - 74	100 - 124	125 - 174	125 - 174
Blue	75 - 99	125 - 149	175 - 199	175 - 224
Red	100 - 124	150 - 174	200 - 224	225 - 249
Gold	125 - 149	175 - 199	225 - 249	250 - 274
Purple	150 +	200 +	250 +	275 +

Tassels

Northern Counties introduced a Metric Tassel on the 1st January 2009 which will run on a similar basis to the existing scheme.



Tassel Award qualifying scores for Metric Clout rounds

Badge	Longbow	Barebow	Recurve	Compound
White	75 - 124	125 - 174	175 - 224	175 - 224
Black	125 - 174	175 - 224	225 - 274	225 - 274
Blue	175 - 199	225 - 249	275 - 299	275 - 299
Red	200 - 224	250 - 274	300 - 319	300 - 319
Gold	225 - 249	275 - 299	320 - 339	320 - 339
Purple	250 +	300 +	340 +	340 +

Six Clout Badge

From the beginning of 2010 a 6 clout badge can now be claimed for any archer achieving a six clout end at a World Archery or Archery GB Metric clout.



Claims for Imperial awards are to be sent to Archery GB, while claims for Metric Awards are to be sent to the NCAS Clout Officer.

Three Clout Badge

This award is for shooting three arrows during one end, in competition into the CLOUT.

The award is open to Longbow Archers and may be claimed at any WA or AGB metric Tassel



Claims for Imperial awards are to be sent to Archery GB, while claims for Metric Awards are to be sent to the NCAS Clout Officer.

Clout Classifications

To gain a classification an Archer must shoot three rounds of, or better than, the qualifying scores as laid down by the NCAS.

Claims for Bowmen, 1st, 2nd and 3rd Class in all disciplines will be administered by the club.

Master and Grand Master Classifications can only be achieved at a Tournament holding Tassel award status.



Clout Classifications

Archery GB Clout – One Way

GENTLEMEN				
CLASS	LONGBOW	BAREBOW	RECURVE	COMPOUND
3 rd	17 – 33	33 – 70	64 – 107	73 – 116
2 nd	34 – 58	71 – 106	108 – 153	117 – 165
1 st	59 – 83	107 – 132	154 – 179	166 – 195
Bowman	84 – 108	133 – 159	180 – 205	196 – 224
MB	109 – 133	160 – 185	206 – 223	225 – 244
GMB	134+	186 +	224 +	245 +

Clout Classifications

Archery GB Clout – One Way

LADIES				
CLASS	LONGBOW	BAREBOW	RECURVE	COMPOUND
3 rd	17 – 34	35 – 74	55 – 100	71 – 113
2 nd	35 – 59	75 – 107	101 – 152	114 – 161
1 st	60 – 84	108 – 128	153 – 179	162 – 189
Bowman	85 – 110	129 – 159	180 – 204	190 – 218
MB	111 – 135	160 – 185	205 – 223	219 – 238
GMB	136+	186 +	224 +	239 +

Clout Classifications

Archery GB Clout – Two Way

GENTLEMEN				
CLASS	LONGBOW	BAREBOW	RECURVE	COMPOUND
3 rd	16 – 31	30 – 70	52 – 95	71 – 112
2 nd	32 – 54	71 – 94	96 – 144	113 – 160
1 st	55 – 77	95 – 117	145 – 170	161 – 188
Bowman	78 – 101	118 – 141	171 – 193	189 – 216
MB	102 – 124	142 – 164	194 – 211	217 – 236
GMB	125+	165 +	212 +	237 +

Clout Classifications

Archery GB Clout – Two Way

LADIES				
CLASS	LONGBOW	BAREBOW	RECURVE	COMPOUND
3 rd	14 – 28	33 – 63	48 – 96	63 – 100
2 nd	29 – 49	64 – 91	97 – 135	101 – 150
1 st	50 – 70	92 – 119	136 – 169	151 – 175
Bowman	71 – 91	120 – 148	170 – 193	176 – 201
MB	92 – 112	150 – 168	194 – 210	202 – 218
GMB	113+	169 +	211 +	219 +

Clout Classifications

World Archery/Metric Clout

GENTLEMEN				
CLASS	LONGBOW	BAREBOW	RECURVE	COMPOUND
3 rd	55 – 106	104 – 157	150 - 201	152 – 204
2 nd	107 – 156	158 – 207	202 - 250	205 – 253
1 st	157 – 181	208 – 232	251 – 274	254 – 278
Bowman	182 – 208	233 – 260	275 – 302	279 – 306
MB	209 - 233	261 – 289	303 – 326	307 – 331
GMB	234 +	290 +	327 +	332 +

Clout Classifications

World Archery/Metric Clout

LADIES				
CLASS	LONGBOW	BAREBOW	RECURVE	COMPOUND
3 rd	56 – 109	101 – 154	148 - 199	146 – 196
2 nd	110 – 160	155 – 205	200 - 247	197 – 244
1 st	161 – 185	206 – 228	248 – 271	245 – 268
Bowman	186 – 213	229 – 255	272 – 298	269 – 295
MB	214 - 239	256 – 282	299 – 322	296 – 319
GMB	240 +	283 +	323 +	320 +

National Records

Can an Archer claim a record for a single Clout using the second round of a double Clout ?

Archery GB Clout

The rules changed on 1st October 2016, with the rule disallowing claims on the 2nd, 3rd etc round shot in a day being deleted, therefore If you shoot a double clout the second clout is now eligible for record claims.

World Archery Clout

Yes - 708. UK Records.

UK records will be maintained for single and double World Archery Clout and Archery GB Metric Clout rounds shot one way. Shooting may be in accordance with either the Archery GB shooting regimes specified in these Rules of Shooting or the World Archery shooting regimes.

Thank you

Clout Archery
Training Presentation

Compiled and Prepared
by

Neil S E Foden

